

# isola

Divano a elementi modulari, componibili, aggregabili, liberi.

Oltre all'elemento più tradizionale, di profondità standard, ci sono elementi di diversa profondità e "geografia": come l'angolare, (quasi un day-bed) e la penisola a "Y".

Sono conformazioni diverse, che permettono di uscire dalla disposizione più abituale della zona relax, per creare isole e penisole che disegnano un paesaggio nuovo, tagliato su misura per rispondere a esigenze diverse.

Il cuoio incornicia il prodotto con dettagli: la base del divano è quasi un vassoio su cui si posano le parti imbottite e rivestite in tessuto.

Sofa with modular elements, modular, aggregatable, free.

In addition to the more traditional element, of standard depth, there are elements of different depth and "geography": such as the angular, (almost a day-bed) and the "Y" peninsula.

They are different conformations, which allow you to leave the most usual arrangement of the relaxation area, to create islands and peninsulas that draw a new landscape, tailored to meet different needs.

The leather frames the product with details: the base of the sofa is almost a tray on which the upholstered and fabric-covered parts rest.

Struttura in legno multistrato e massello con molleggio seduta su cinghie elastiche. Imbottitura in poliuretano espanso a quote differenziate.

Rivestimenti cuscini in tessuto o pelle. Zoccolo con fasce in cuoietto P3.

Structure in solid wood and plywood with suspension seat on elastic belts.

Padding in polyurethane foams with different densities.

Cushion upholstery in fabric or leather. Bottom profiles in thick leather P3.

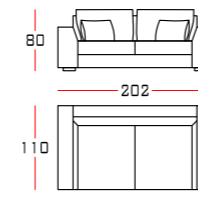

2P

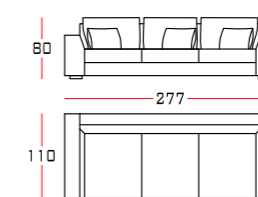

3P

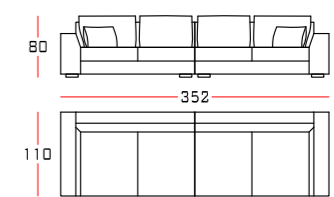

4P

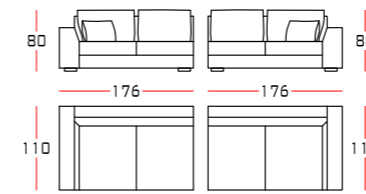

2 PBS-PBD

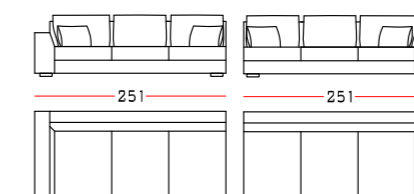

3 PBS-PBD

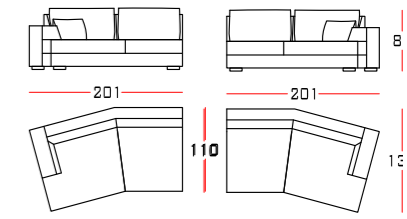

2 PBYS - 2 PBYD

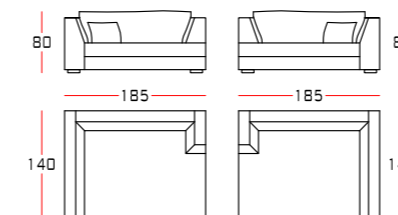

ANGS-ANGD

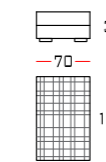

PR

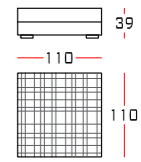

PQ

**NOTE**

2/3/4 P= 2/3/4 posti | seats

2/3 PBS= 2/3 posti bracciolo sinistro | 2/3 seats left armrest

2/3 PBD= 2/3 posti bracciolo destro | 2/3 seats right armrest

2 PBYS= 2 posti obliquo bracciolo sinistro | 2 seats oblique left armrest

2 PBYD= 2 posti obliquo bracciolo destro | 2 seats oblique right armrest

PR= pouf rettangolare | rectangular pouf

PQ= pouf quadrato | square pouf

ANG= angolare | corner seat

# compositions

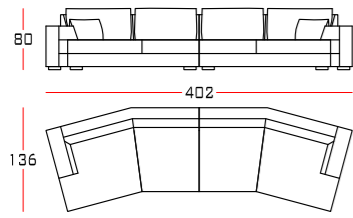

2 PBYS+2 PBYD

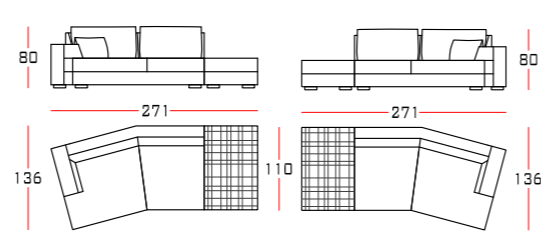

2 PBYS + PR / 2 PBYD + PR

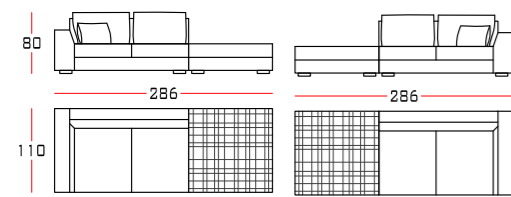

2 PBS + PQ / 2 PBD + PQ

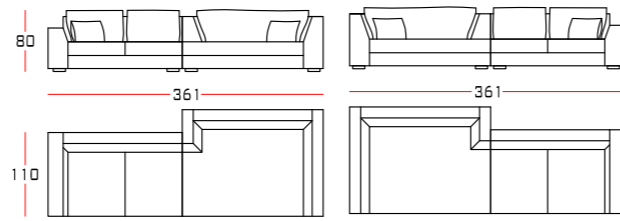

ANGS + 2 PBS / ANGD + 2 PBD

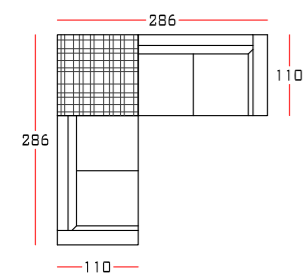

2 PBS + 2 PBD + PQ

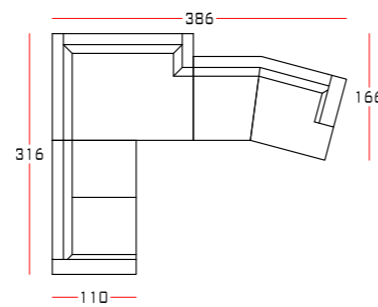

2 PBS + 2 PBYD + ANG

# thick leather CAT.P3

bottom profiles

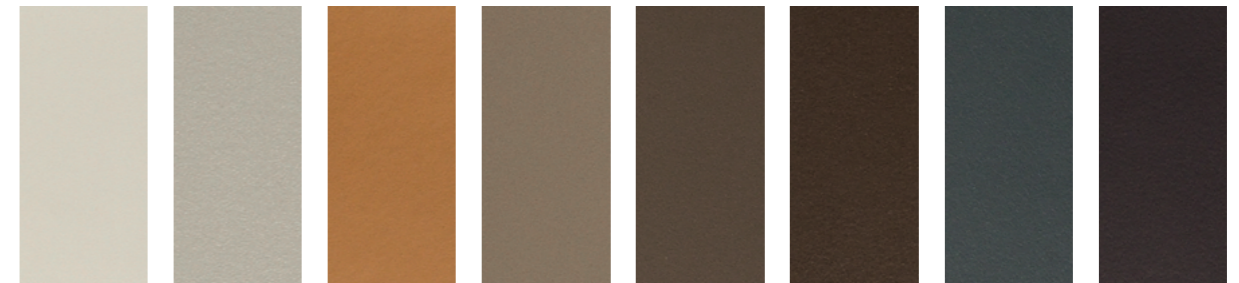

C23 Ghiaccio

C01 Silver

C39 Sella

C29 Taupe

C28 Fango

C31 Tabacco

C18 Grafite

C32 Caffè



C11 Moka

C09 Nero

# leather CAT. P3 DELTA

cushions



010

434

015

121

090

051

029

1062

# leather CAT. P2 NUVOLA

cushions



117 Neve 198 Ostrica 199 Canapa 179 Lino 159 Creta 174 Siena 208 Zabaione 131 Cuoio

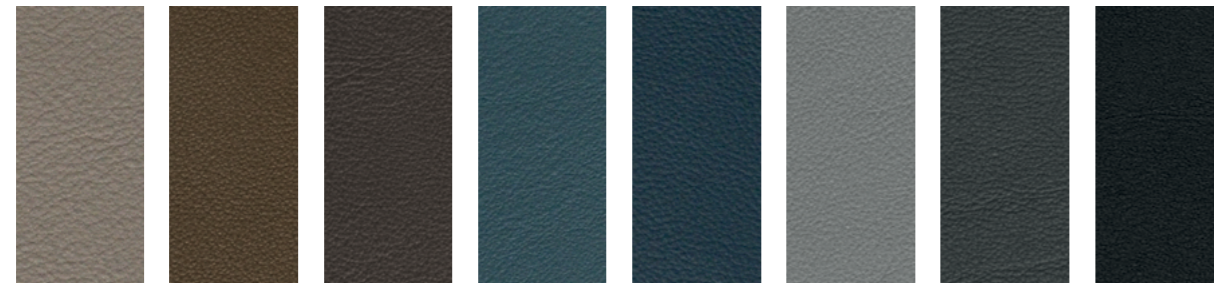

207 Camoscio 217 Fango 147 Moretto 164 Ottanio 154 Zaffiro 203 Elefante 141 Antracite 101 Nero

# leather CAT.P1 NABUK

cushions

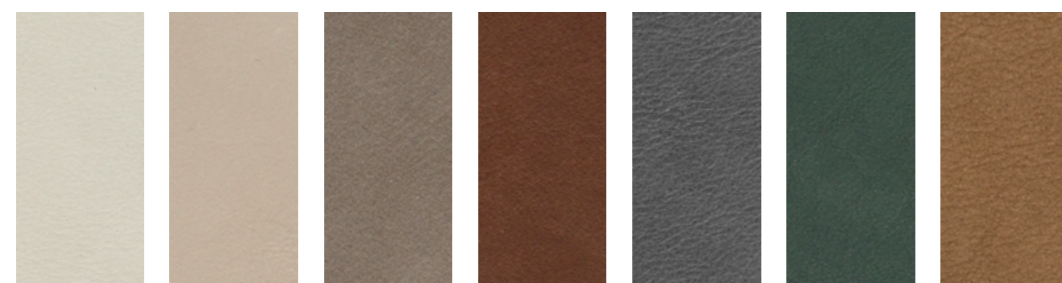

2 Mediterraneo 3 Mediterraneo 23 Mediterraneo 22 Mediterraneo 9 Mediterraneo 11 Mediterraneo 8008 Mediterraneo

# fabrics CAT.A TUNDRA

cushions

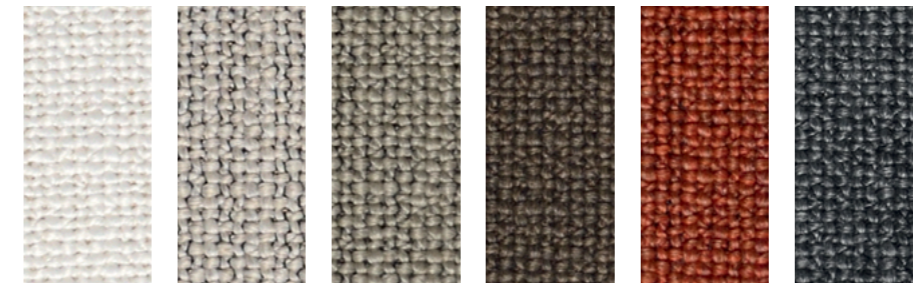

07 03 30 06 09 11

# fabrics CAT.A DUNE

cushions

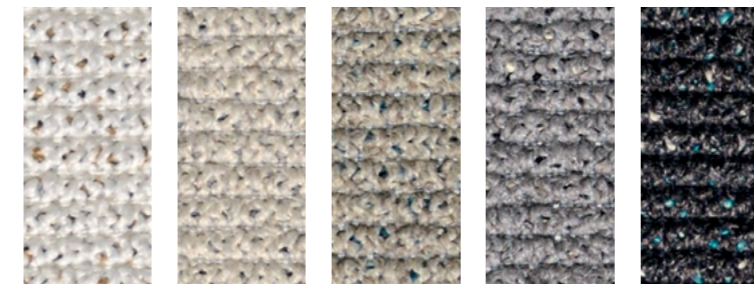

01/1 02 03/11 20 18/2

# fabrics CAT.B+ GOBI

cushions

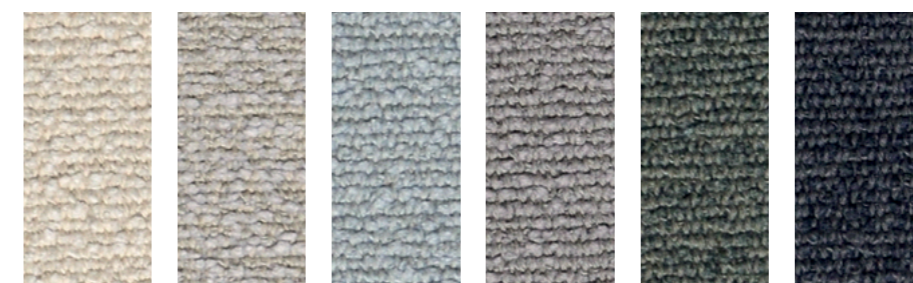

H865 H867 H872 H873 H871 H875

# fabrics CAT.B+ EMYR GRS

cushions



14      05/2      34/2      20/1      200

# woods

structure



Noce Italiano Biondo      Teak Gold      Noce Canaletto      Rovere thermo

# fabrics CAT.B VALERYE

cushions



305      336      341      315      332      329

Dimensions in centrimetres. The company has the right to modify the models without prior notice. The information given here are based on the latest product information available at the time of printing.

Shades of colours shown as samples may vary due to the fact that they appear on paper, it is for this reason that all colours are considered indicative and the company will not be liable for differences should they arise in the final product.